

1591S Enclosure

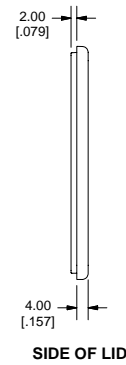

Note:

Enclosures can be Factory Modified (Milling, Drilling, Printing etc.)
Solid models of this enclosure available in STEP or IGES Format.
Contact Factory mjm@hammondmfg.com

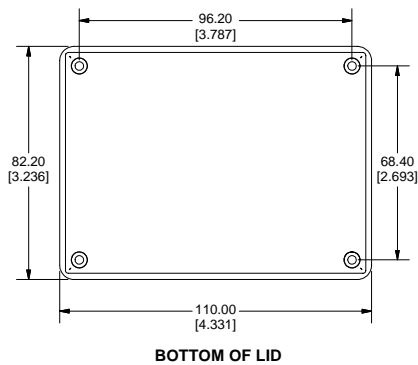
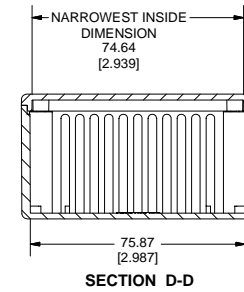
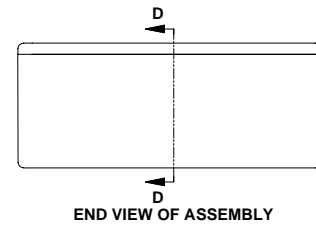
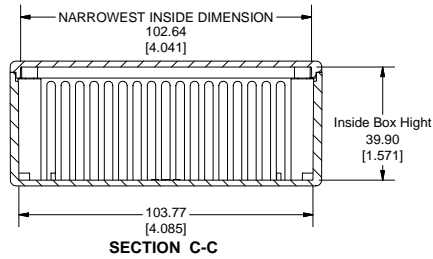
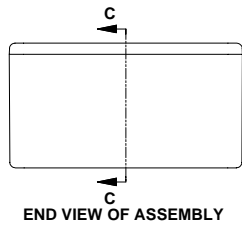
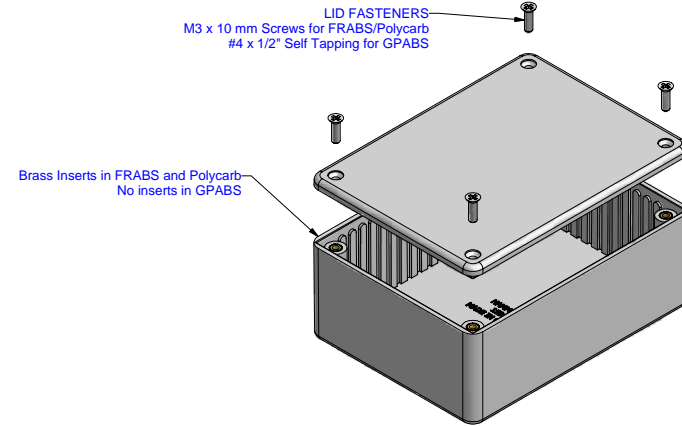
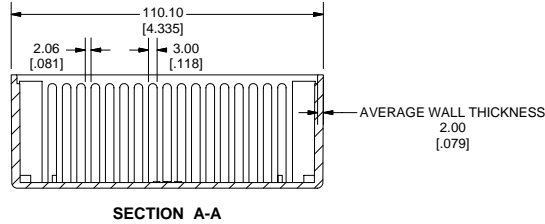
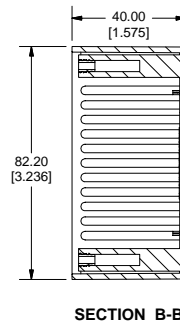
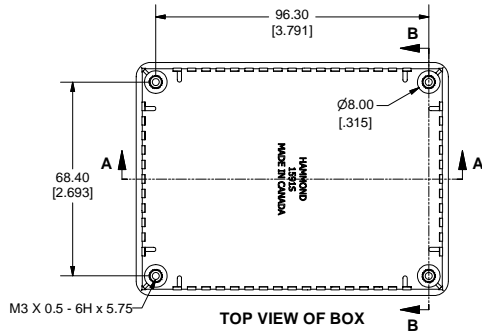
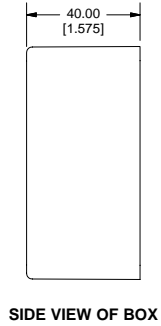

PART NUMBERS		
1591S Enclosures		
Material	Colour	Part Number
FR ABS UL94 - V0	Black	1591SBK
	Grey	1591SGY
	Black Shielded (Conductive Paint)	1591RSBK
GP ABS	Black	1591SSBK
	Grey	1591SSGY
Translucent Polycarbonate	Ice Blue	1591STBU
	IR Red	1591STRD
	Crystal Clear	1591STCL
Accessories		
Description	Part Number	
Universal Application	PC Board Card Adapters	See Accessories Section
	Flange Kits	See Accessories Section
	Clear Lids - clear, flame retardant polycarbonate - Lid ONLY	1591SC
FR ABS & Polycarbonate	Replacement Screws, Flat head Phillips, Nickel Plated Pkg of 100	1591MS100 1591MS100BK (Black)
	Self Tapping Pkg of 100	1591TS100 1591TS100BK (Black)
Required Torque on Fasteners (no lubrication)		
M3 - 0.5 x 10mm Screws		30-40 cN'm
#4 x 0.5 Screws		30-40 cN'm